



2017 PEUGEOT RCC-SP70P MANUAL

MAIN UNIT OF INTERFACE



PEUGEOT
[RCC-SP70P]

Car Brand	Model	Year Range	System
PEUGEOT	RCC-SP70P	2017	

COMPONENTS

<p>1 MAIN UNIT</p>	<p>2 MAIN CABLE</p>	<p>3 RGB CABLE</p>	<p>4 REMOTE CONTROL</p>
<p>5 TOUCH CABLE</p>	<p>6 LVDS CABLE</p>	<p>7 LVDS GENDER</p>	<p>8 4PIN FILM</p>
<p>9 AV IN/OUT CABLE</p> <p>※ OPTION ※</p>	<p>10 AV GENDER CABLE</p> <p>※ OPTION ※</p>	<p>11 AV GENDER BOARD</p> <p>※ OPTION ※</p>	

CONNECTION (RCC-SP70P)

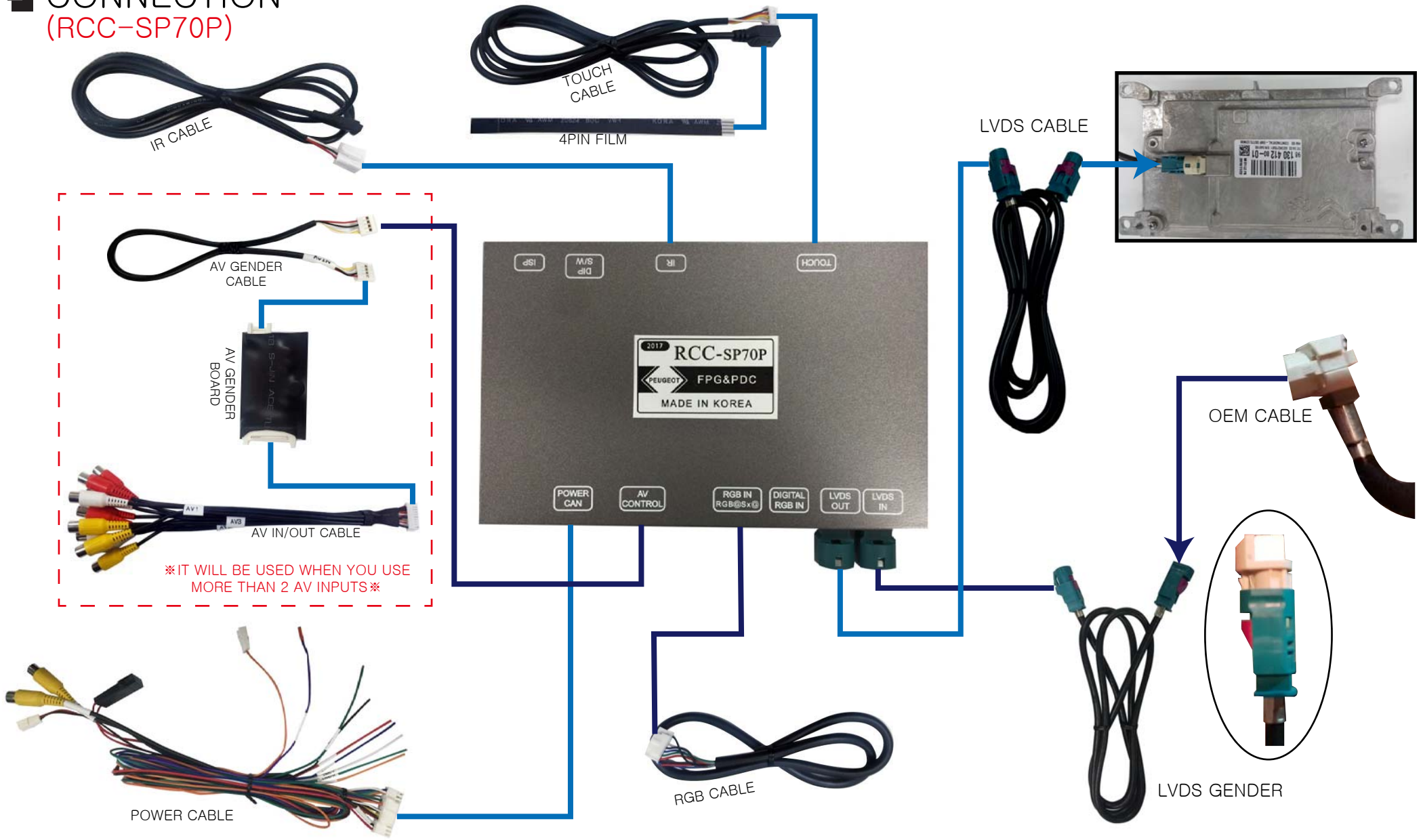

IT WILL BE USED WHEN YOU USE MORE THAN 2 AV INPUTS

DIP S/W

OFF : ↑ (UP) / ON : ↓ (DOWN)

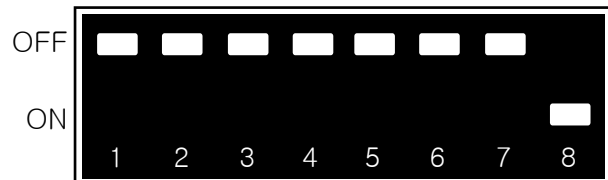

PIN	FUNCTION	DIP S/W SETTING
1	GPS INPUT MUTE	OFF : DO NOT USE GPS ON : USE GPS
2	VEHICLE SETTING	
3	VEHICLE SETTING	
4	REAR CAMERA	OFF : OEM ON : AFTERMARKET CAMERA
5		NC
6		NC
7	DISPLAY SETTING	OFF : 800 X 480 ON : 400 X 234
8		ON

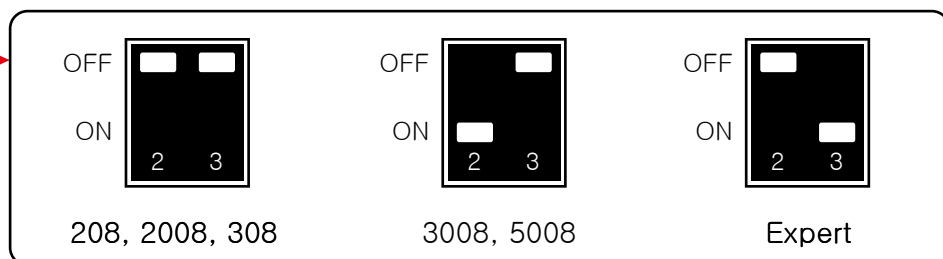

RCC-SP70P SPEC

1. INPUT SPEC

- 1 x Analog RGB Input(GPS system output)
- 1 x LVDS Input
- 1 x LVDS output
- 1 x CVBS(rear camera)
- 1 x CVBS(front camera or A/V)
- 3 x A/V Input(Option)

2. POWER SPEC

Input power : 8VDC ~ 24VDC
Consumption : 5WATT

3. SIZE

154*98*20mm(Width*Length*Height)

4. POWER 24pin

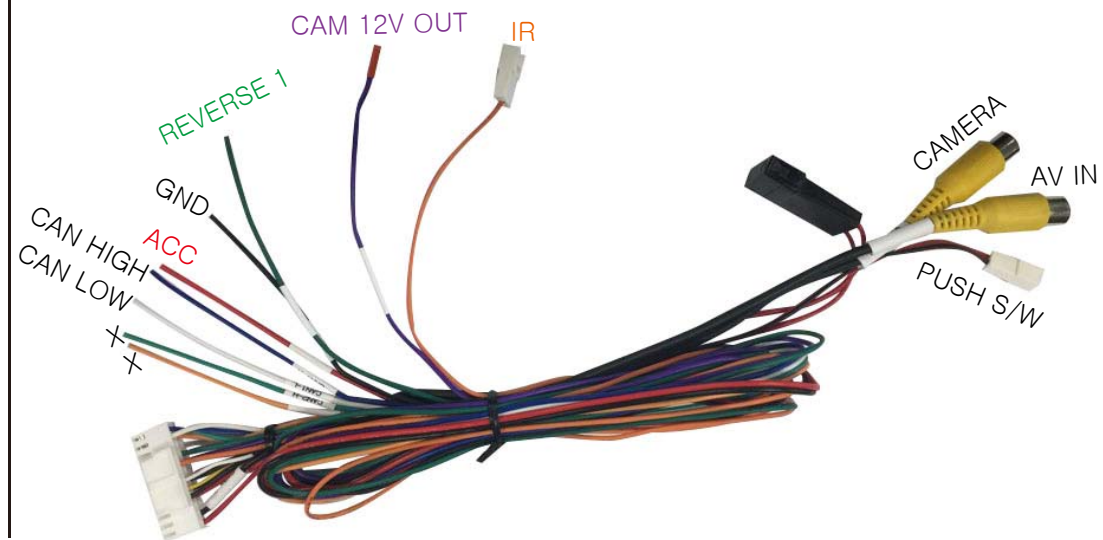

HOW TO CONNECT(3-1)

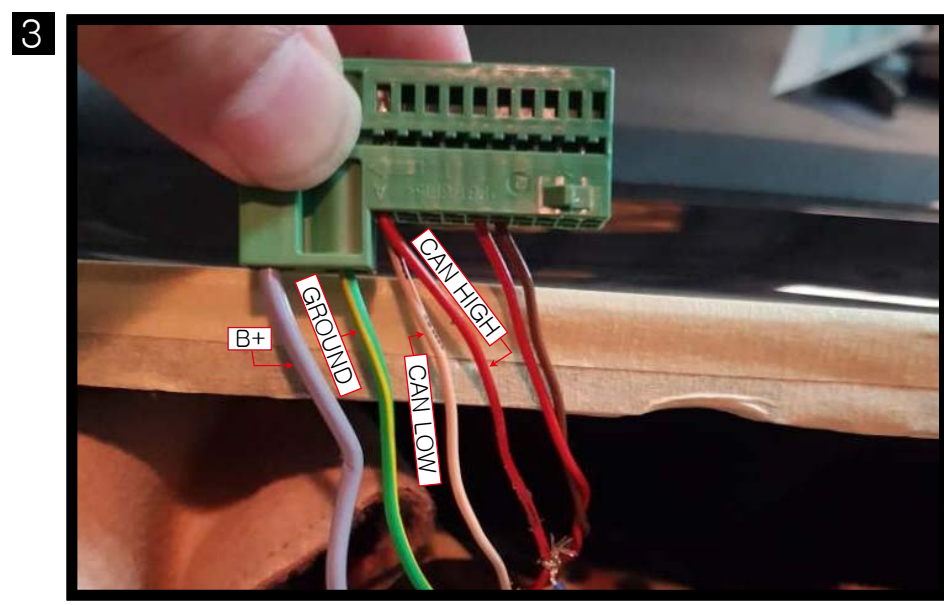
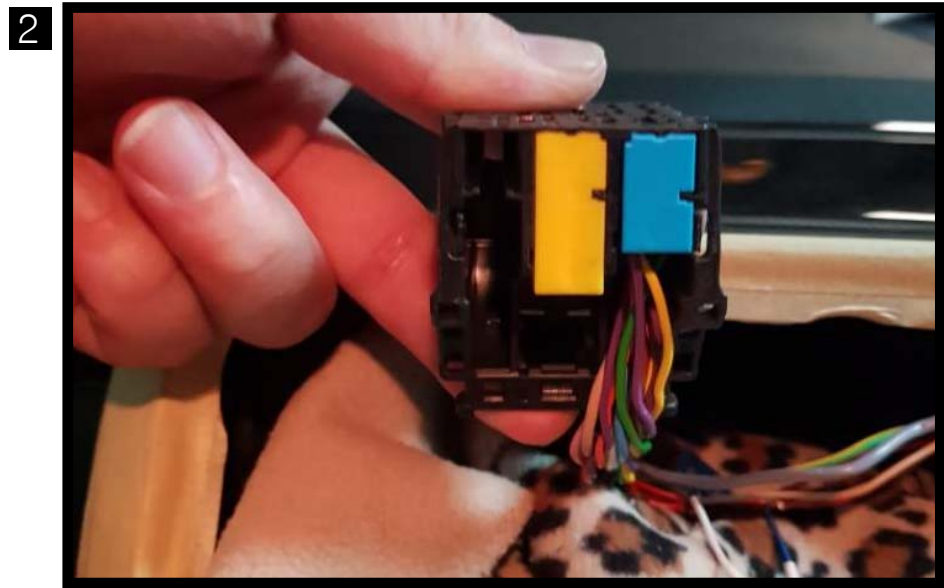
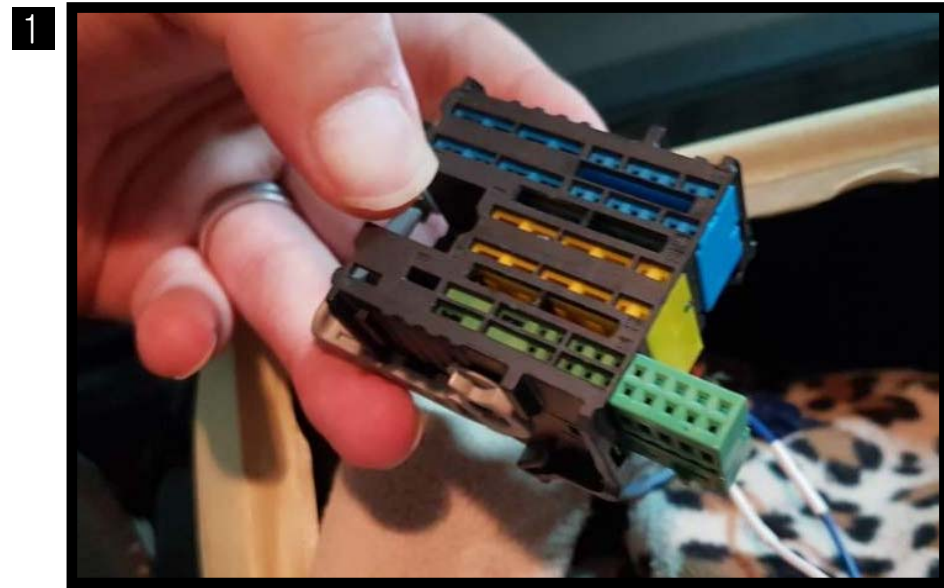

HOW TO CONNECT(3-2)

1



2



- PLEASE ENTER TO OUR OSD MENU TO SET CAR TYPE AS BELOW WHEN THE EXTERNAL SCREEN DIM THAN FACTORY SCREEN.
- MENU -> SETTING -> CAR TYPE -> CAR TYPE 2
PLEASE RECONNECT POWER CABLE OF INTERFACE AFTER SETTING

HOW TO CONNECT(3-3)

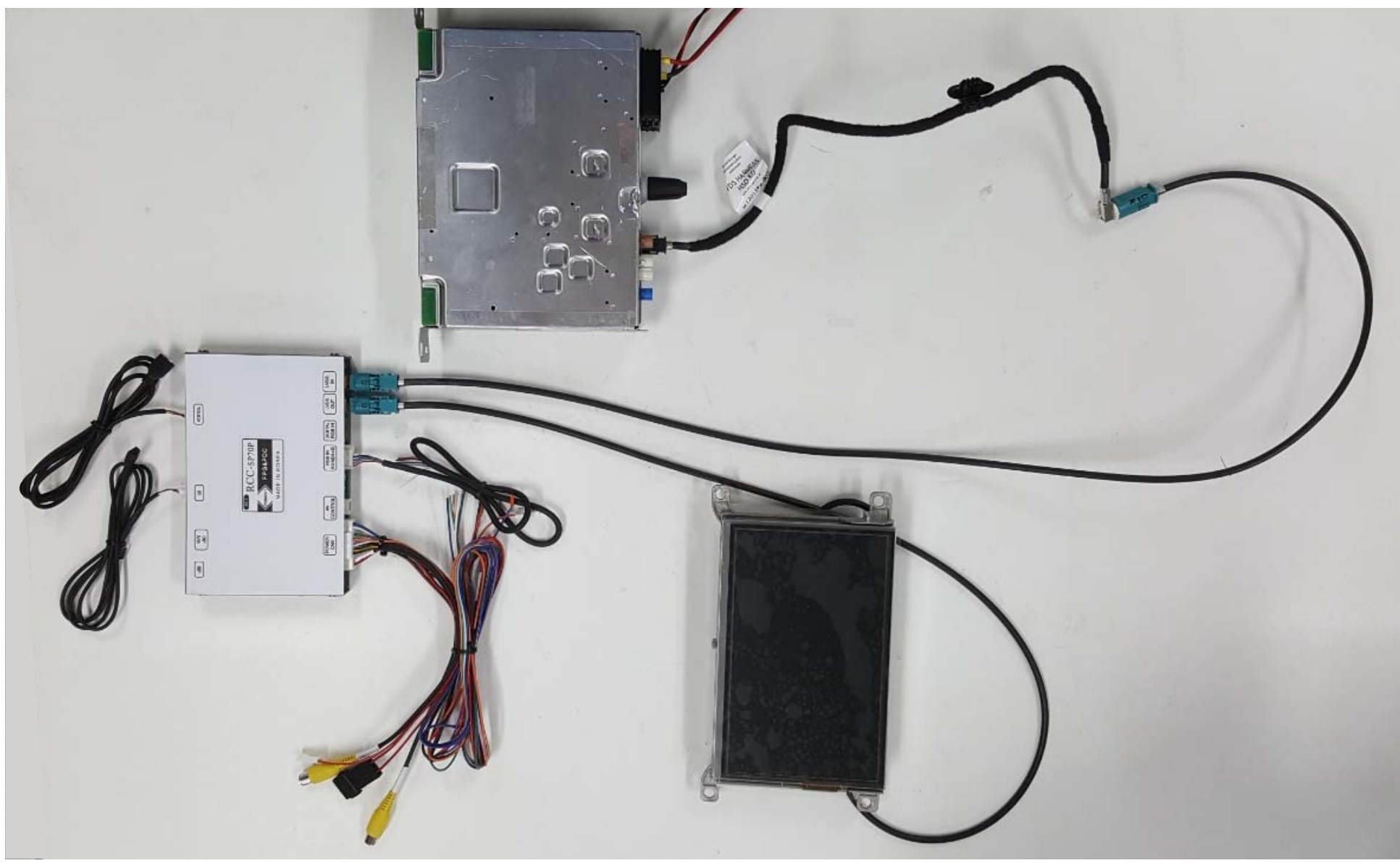

HOW TO SWITCH SCREEN(2-1)

208



PRESS  FOR SHORT WILL SWITCH SCREEN

Expert



PRESS  FOR 2S WILL SWITCH SCREEN

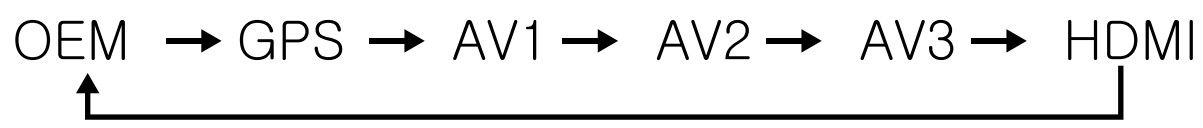

※ IT IS POSSIBLE TO TOUCH CONTROL DTV, DVD, BLACK BOX BY OUR TOUCH UI ※

HOW TO SWITCH SCREEN(2-2)

3008

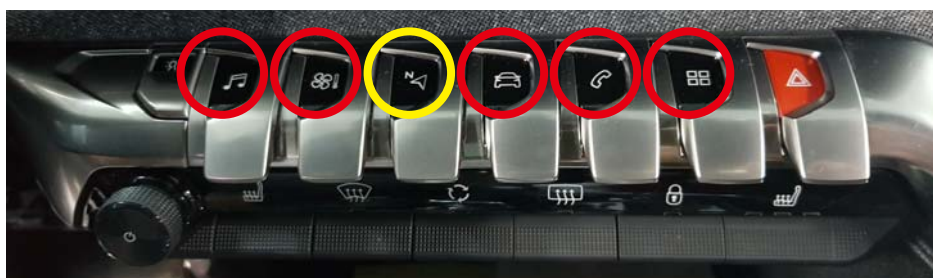

PRESS , FOR SHORT WILL SWITCH SCREEN

3008



PRESS , , , , BUTTONS TO SWITCH BACK TO FACTORY SCREEN DIRECTLY

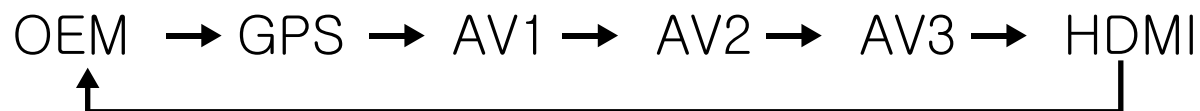

※ IT IS POSSIBLE TO TOUCH CONTROL DTV, DVD, BLACK BOX BY OUR TOUCH UI ※

HOW TO CONNECT VIDEO AUDIO WHEN YOU ONLY USE ONE AV INPUT

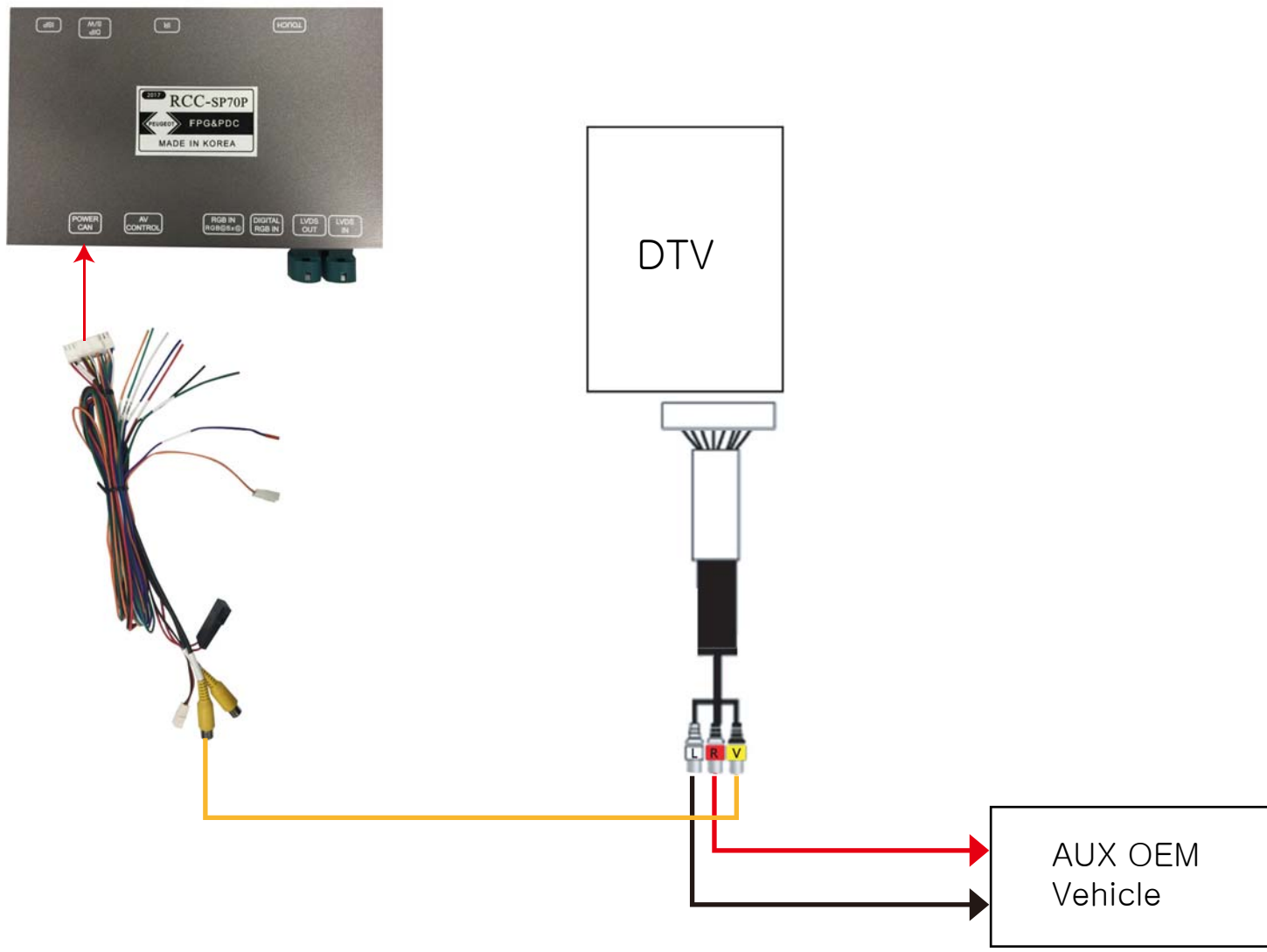

HOW TO CONNECT VIDEO AUDIO WHEN YOU USE MORE THAN 2 AV INPUTS

